

2 A

General Notes:

Not to Scale

Due to continual product development, detail and technical data are subject to change without notice

For latest product specifications please go to our website: www.intlwindow.com or contact your IWC Representative

This is an architectural view of cross sections only and installation of shims, fasteners and sealant shall be the responsibility of the installer

IWC

SERIES 6220 AWNING WINDOW X
VERTICAL CUT DETAIL 51 & 52

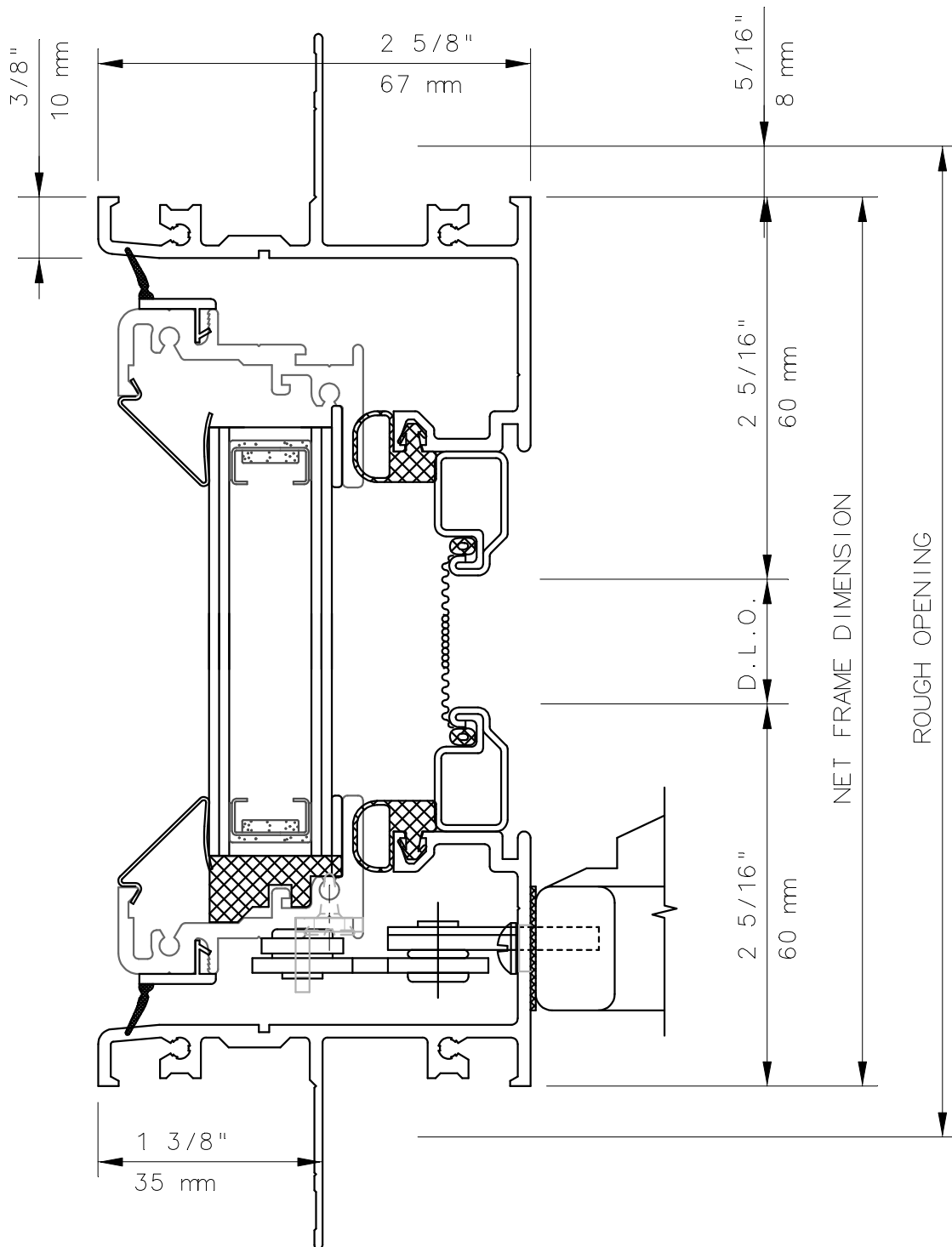

NOTE

THIS IS AN ARCHITECTURAL VIEW OF CROSS SECTIONS ONLY AND INSTALLATION OF SHIMS, FASTENERS, AND SEALANT SHALL BE THE RESPONSIBILITY OF THE INSTALLER.

INTERNATIONAL WINDOW - NORTHERN CAL.

30526 SAN ANTONIO STREET
HAYWARD, CALIFORNIA 94544
(510) 487-1122 ORDER DESK (510) 487-1234
FAX # (510) 471-9387 OR (510) 489-3020

INTERNATIONAL WINDOW CORPORATION

1551 EAST ORANGETHORPE AVE.
FULLERTON, CALIFORNIA 92831
(562) 928-6411 (800) 477-4032
FAX # (562) 928-3492

IWC

SERIES 6220 AWNING WINDOW X HORIZONTAL CUT DETAIL 53 & 53R

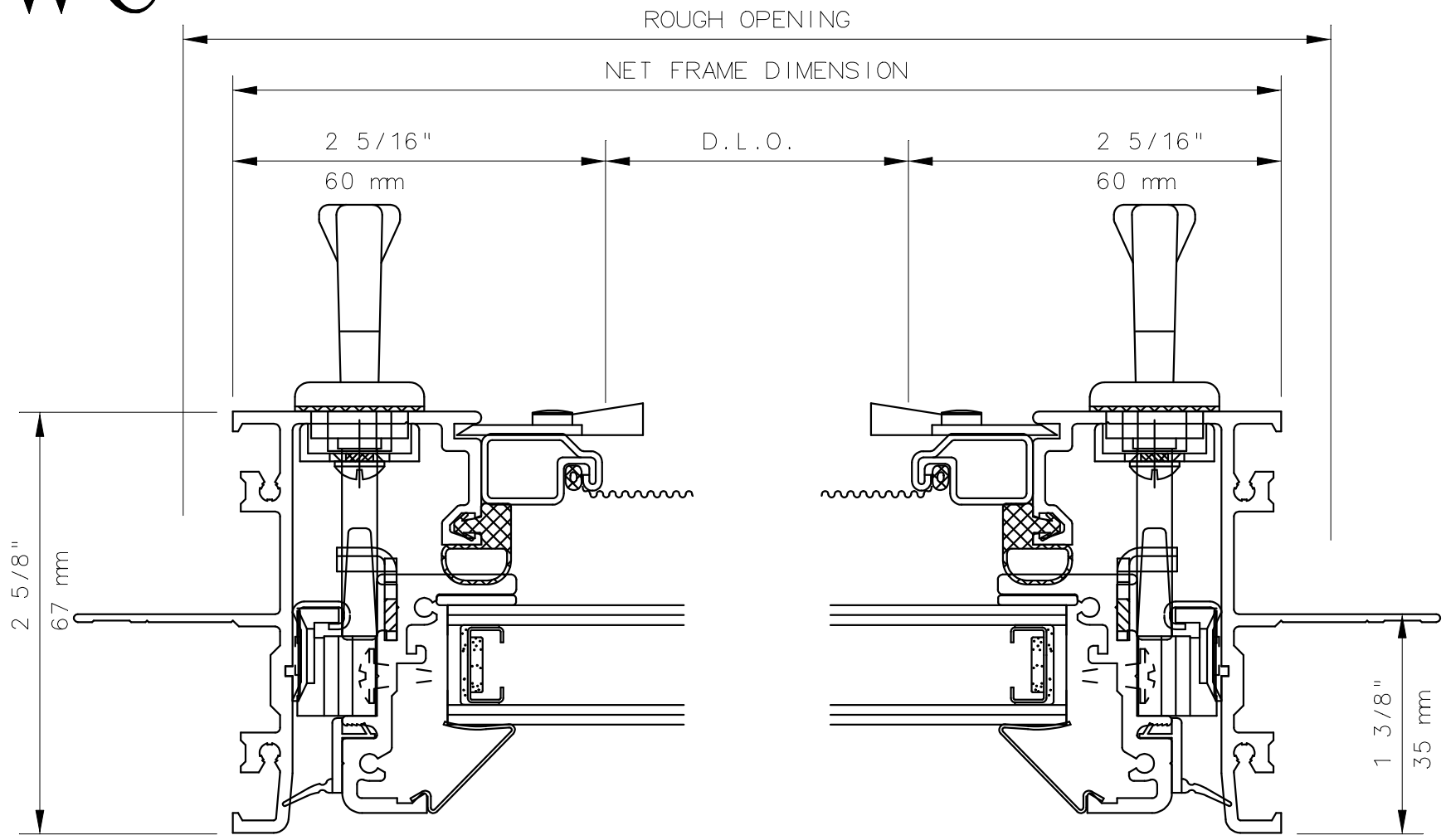

NOTE

THIS IS AN ARCHITECTURAL VIEW OF CROSS SECTIONS ONLY AND INSTALLATION OF SHIMS, FASTENERS, AND SEALANT SHALL BE THE RESPONSIBILITY OF THE INSTALLER.

INTERNATIONAL WINDOW - NORTHERN CAL.

30526 SAN ANTONIO STREET
HAYWARD, CALIFORNIA 94544
(510) 487-1122 ORDER DESK (510) 487-1234
FAX # (510) 471-9387 OR (510) 489-3020

INTERNATIONAL WINDOW CORPORATION

1551 EAST ORANGETHORPE AVE.
FULLERTON, CALIFORNIA 92831
(562) 928-6411 (800) 477-4032
FAX # (562) 928-3492

IWC

SERIES 6220/21/60/80 AWNING WINDOW
INTEGRAL MULLION 2A DETAIL 64

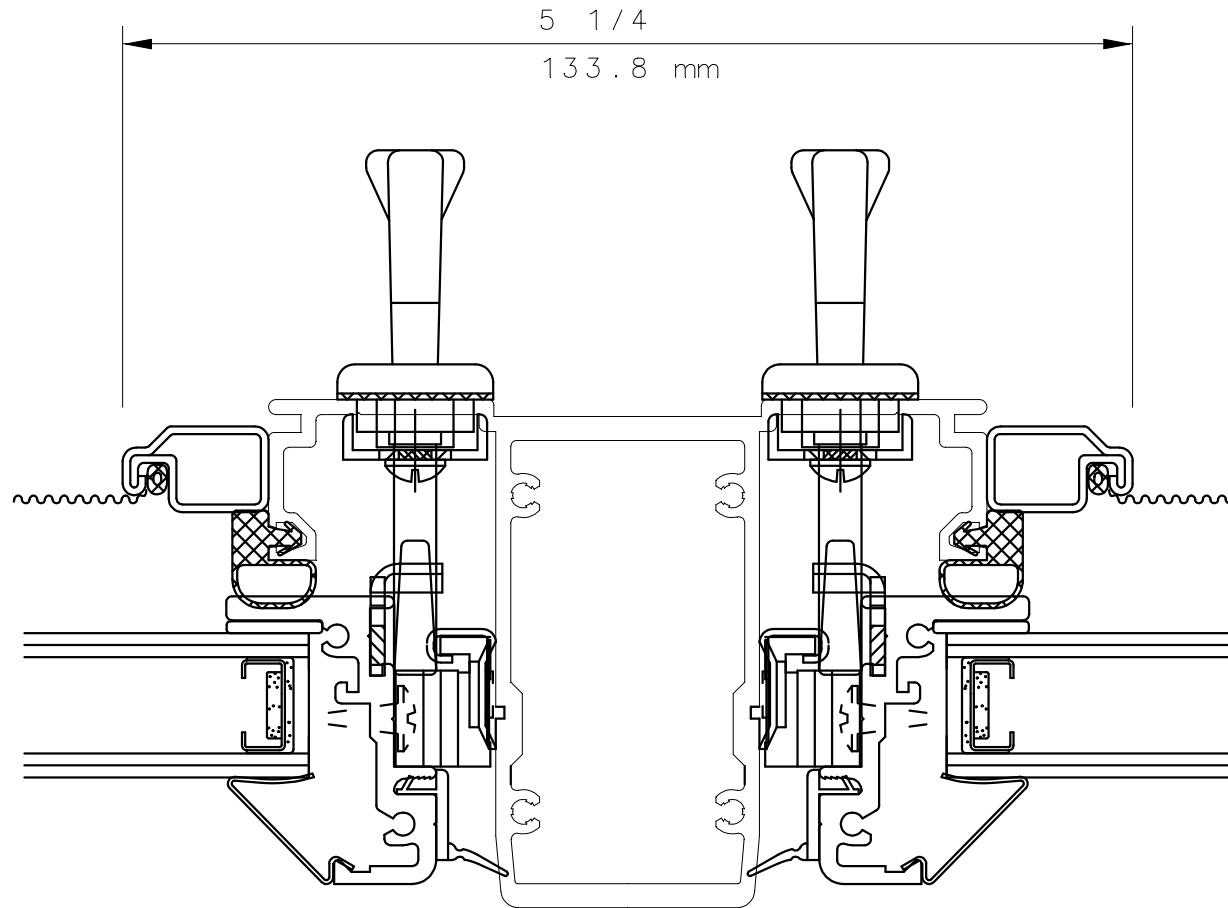

NOTE

THIS IS AN ARCHITECTURAL VIEW OF CROSS SECTIONS ONLY AND INSTALLATION OF SHIMS, FASTENERS, AND SEALANT SHALL BE THE RESPONSIBILITY OF THE INSTALLER.

INTERNATIONAL WINDOW - NORTHERN CAL.

30526 SAN ANTONIO STREET
HAYWARD, CALIFORNIA 94544
(510) 487-1122 ORDER DESK (510) 487-1234
FAX # (510) 471-9387 OR (510) 489-3020

INTERNATIONAL WINDOW CORPORATION

1551 EAST ORANGETHORPE AVE.
FULLERTON, CALIFORNIA 92831
(562) 928-6411 (800) 477-4032
FAX # (562) 928-3492