

OXXO SLIDING GLASS DOOR 4 1/2" & 5 1/2" FRAME

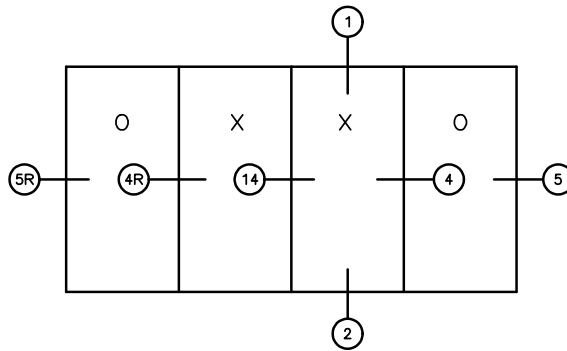

General Notes:

Not to Scale

Due to continual product development, detail and technical data are subject to change without notice

For latest product specifications please go to our website: [www.intlwindow.com](http://www.intlwindow.com) or contact your IWC Representative

This is an architectural view of cross sections only and installation of shims, fasteners and sealant shall be the responsibility of the installer

# IWC

## SERIES 5821 HORIZONTAL SLIDING DOOR HEAD VERTICAL CUT DETAIL 1

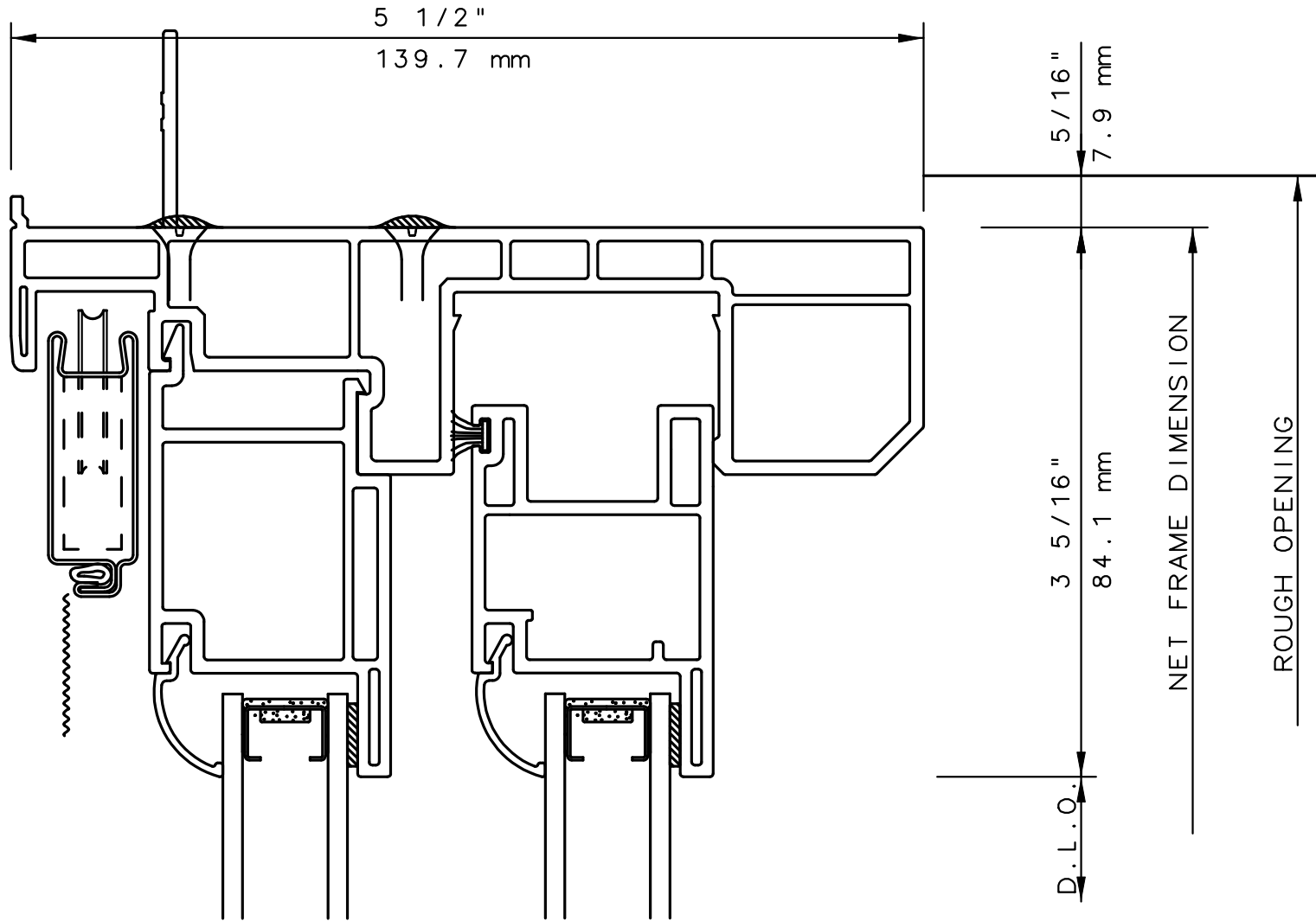

**NOTE**

THIS IS AN ARCHITECTURAL VIEW OF CROSS SECTIONS ONLY AND INSTALLATION OF SHIMS, FASTENERS, AND SEALANT SHALL BE THE RESPONSIBILITY OF THE INSTALLER.

**INTERNATIONAL WINDOW - NORTHERN CAL.**

30526 SAN ANTONIO STREET  
HAYWARD, CALIFORNIA 94544  
(510) 487-1122 ORDER DESK (510) 487-1234  
FAX # (510) 471-9387 OR (510) 489-3020

**INTERNATIONAL WINDOW CORPORATION**

1551 EAST ORANGETHORPE AVE.  
FULLERTON, CALIFORNIA 92831  
(562) 928-6411 (800) 477-4032  
FAX # (562) 928-3492

# IWC

## SERIES 5821 HORIZONTAL SLIDING DOOR SILL VERTICAL CUT DETAIL 2

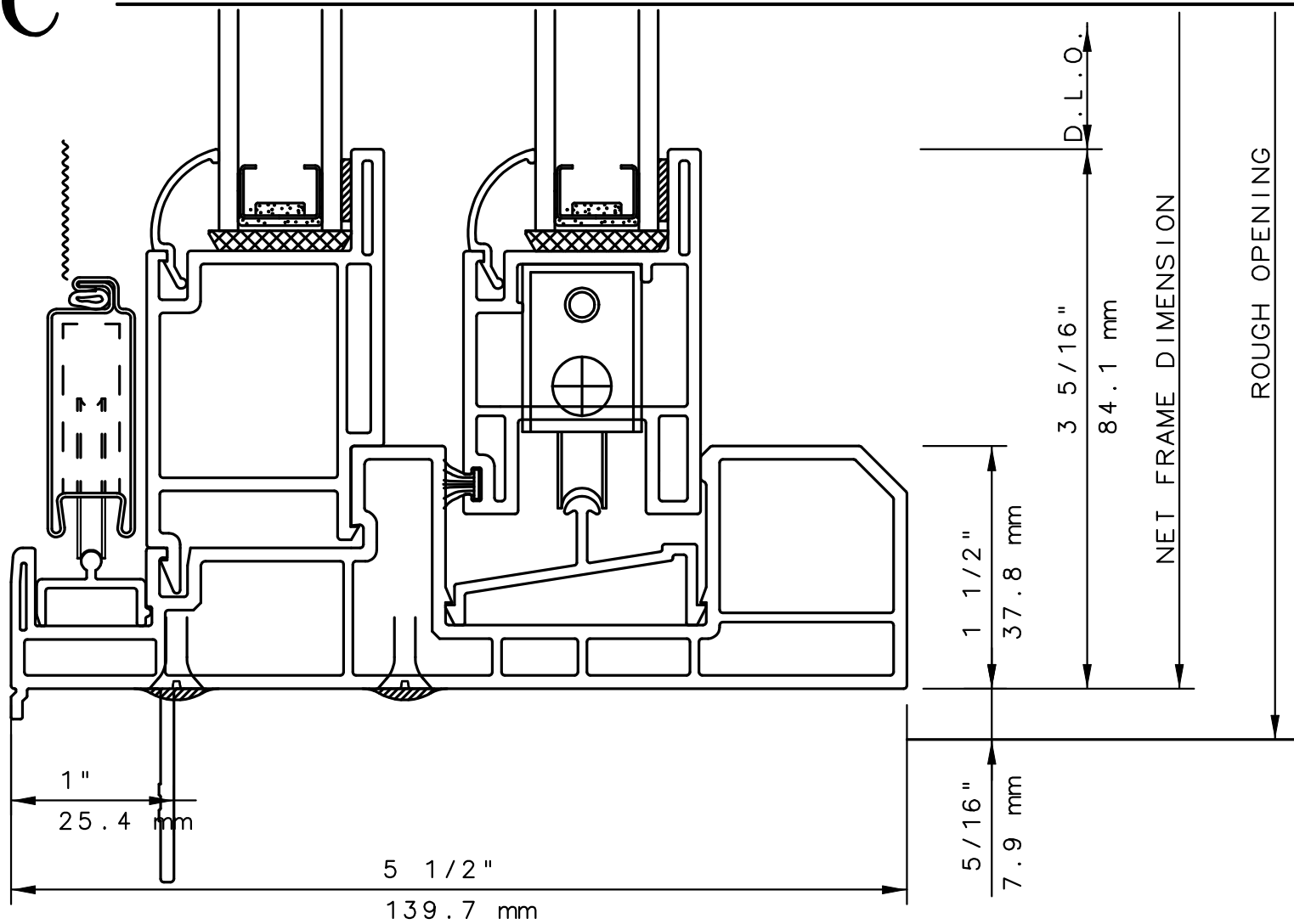

**NOTE**

THIS IS AN ARCHITECTURAL VIEW OF CROSS SECTIONS ONLY AND INSTALLATION OF SHIMS, FASTENERS, AND SEALANT SHALL BE THE RESPONSIBILITY OF THE INSTALLER.

**INTERNATIONAL WINDOW - NORTHERN CAL.**

30526 SAN ANTONIO STREET  
HAYWARD, CALIFORNIA 94544  
(510) 487-1122 ORDER DESK (510) 487-1234  
FAX # (510) 471-9387 OR (510) 489-3020

**INTERNATIONAL WINDOW CORPORATION**

1551 EAST ORANGETHORPE AVE.  
FULLERTON, CALIFORNIA 92831  
(562) 928-6411 (800) 477-4032  
FAX # (562) 928-3492

# IWC

SERIES 5820, 21, 60, 80 HORIZONTAL SLIDING DOOR  
MULLION HORIZONTAL CUT DETAIL 4

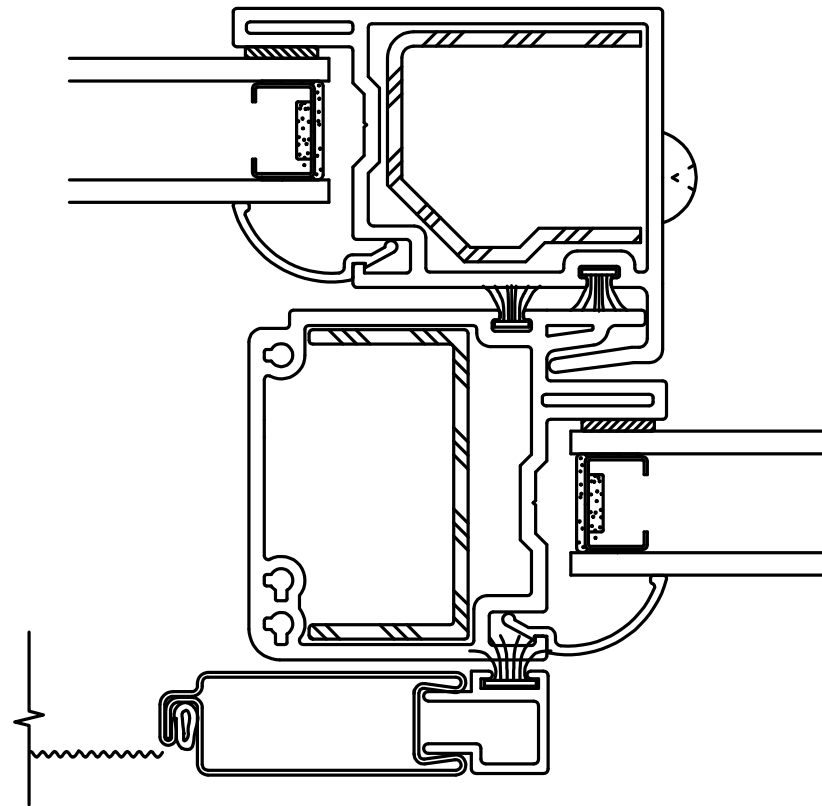
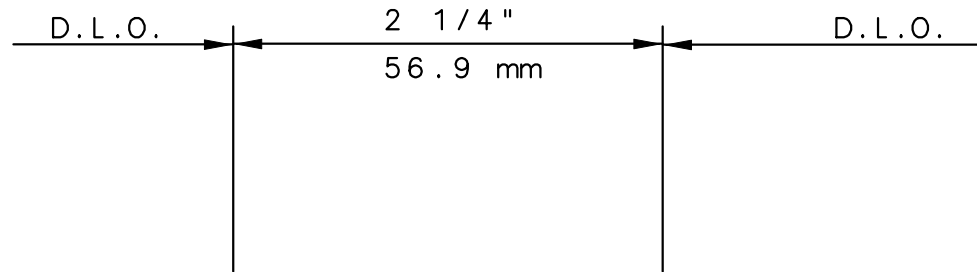

**NOTE**

THIS IS AN ARCHITECTURAL VIEW OF CROSS SECTIONS ONLY AND INSTALLATION OF SHIMS, FASTENERS, AND SEALANT SHALL BE THE RESPONSIBILITY OF THE INSTALLER.

**INTERNATIONAL WINDOW - NORTHERN CAL.**

30526 SAN ANTONIO STREET  
HAYWARD, CALIFORNIA 94544  
(510) 487-1122 ORDER DESK (510) 487-1234  
FAX # (510) 471-9387 OR (510) 489-3020

**INTERNATIONAL WINDOW CORPORATION**

1551 EAST ORANGETHORPE AVE.  
FULLERTON, CALIFORNIA 92831  
(562) 928-6411 (800) 477-4032  
FAX # (562) 928-3492

# IWC

## SERIES 5821 HORIZONTAL SLIDING DOOR FIXED JAMB HORIZONTAL CUT DETAIL 5

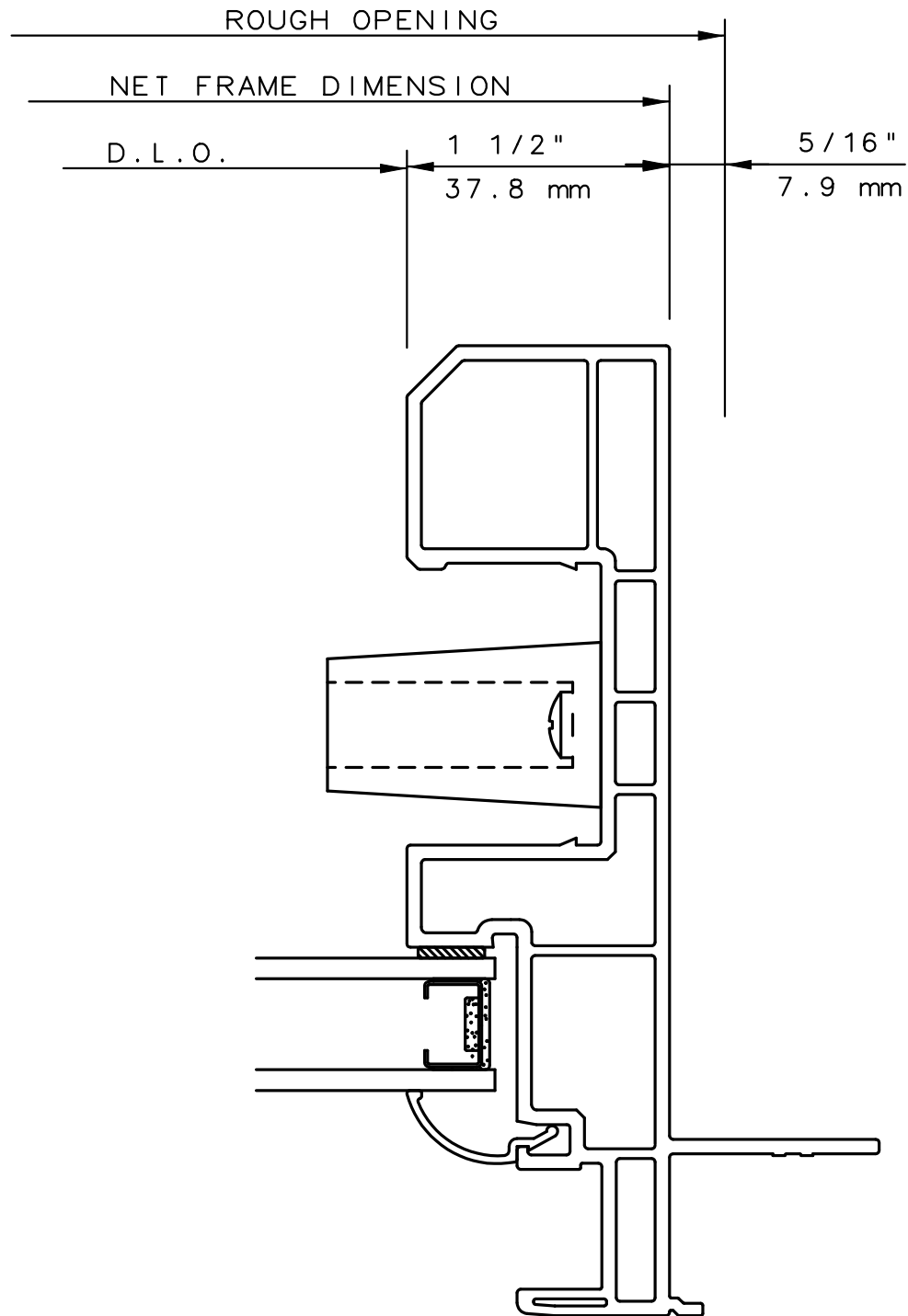

### **NOTE**

THIS IS AN ARCHITECTURAL VIEW OF CROSS SECTIONS ONLY AND INSTALLATION OF SHIMS, FASTENERS, AND SEALANT SHALL BE THE RESPONSIBILITY OF THE INSTALLER.

### **INTERNATIONAL WINDOW - NORTHERN CAL.**

30526 SAN ANTONIO STREET  
HAYWARD, CALIFORNIA 94544  
(510) 487-1122 ORDER DESK (510) 487-1234  
FAX # (510) 471-9387 OR (510) 489-3020

### **INTERNATIONAL WINDOW CORPORATION**

1551 EAST ORANGETHORPE AVE.  
FULLERTON, CALIFORNIA 92831  
(562) 928-6411 (800) 477-4032  
FAX # (562) 928-3492

# IWC

## SERIES 5820/21/60/80 HORIZONTAL SLIDING DOOR OXO MULLION VERTICAL CUT DETAIL 14

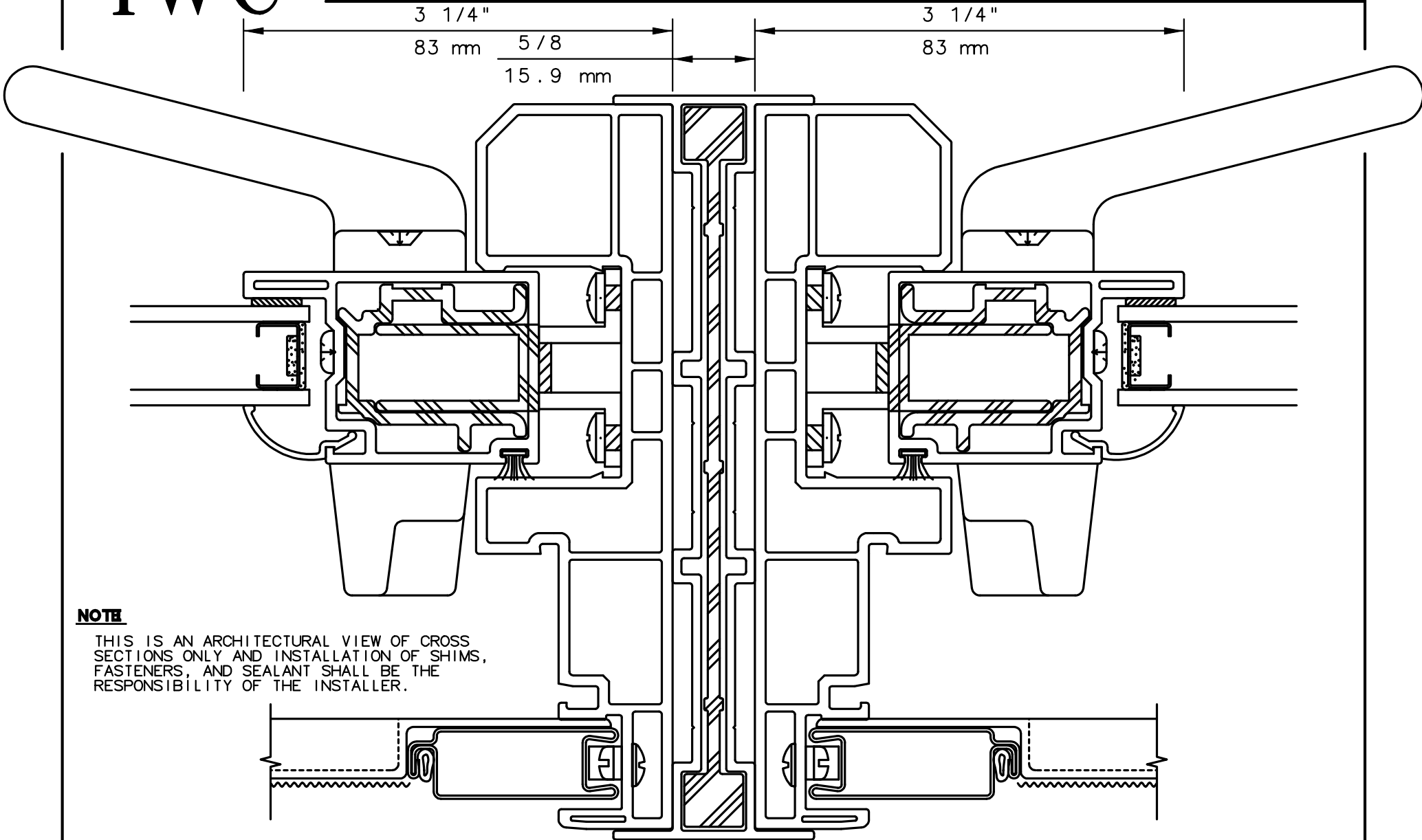

**NOTE**

THIS IS AN ARCHITECTURAL VIEW OF CROSS SECTIONS ONLY AND INSTALLATION OF SHIMS, FASTENERS, AND SEALANT SHALL BE THE RESPONSIBILITY OF THE INSTALLER.

**INTERNATIONAL WINDOW - NORTHERN CAL.**

30526 SAN ANTONIO STREET  
HAYWARD, CALIFORNIA 94544  
(510) 487-1122 ORDER DESK (510) 487-1234  
FAX # (510) 471-9387 OR (510) 489-3020

**INTERNATIONAL WINDOW CORPORATION**

1551 EAST ORANGETHORPE AVE.  
FULLERTON, CALIFORNIA 92831  
(562) 928-6411 (800) 477-4032  
FAX # (562) 928-3492