

GENTRY
5400 SERIES

Side Load Single Hung

SERIES 5420 / 21 / 60 / 80 SIDE LOAD SINGLE HUNG WINDOWS

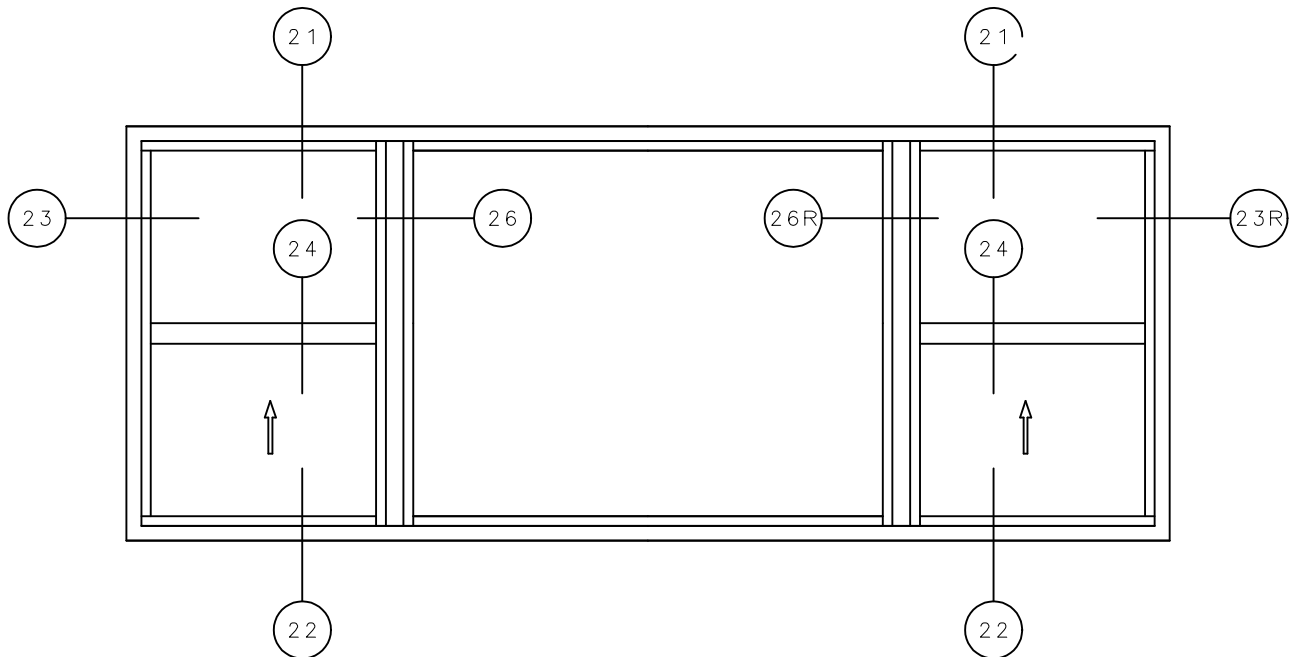

1 / 1 | 0 | 1 / 1
INTEGRAL MULLION

General Notes:

Not to Scale

Due to continual product development, detail and technical data are subject to change without notice

For latest product specifications please go to our website: www.intlwindow.com or contact your IWC Representative

This is an architectural view of cross sections only and installation of shims, fasteners and sealant shall be the responsibility of the installer



IWC - SOUTHERN CA | IWC - NORTHERN CA
GENTRY 5400 | WWW.INTLWINDOW.COM

Rev. 0713 Form: 5400slsh__1-11011-1__el_i.pdf
IWC Architectural Design Detail

IWC

SERIES 5460 SINGLE HUNG WINDOW
HEAD DETAIL 21

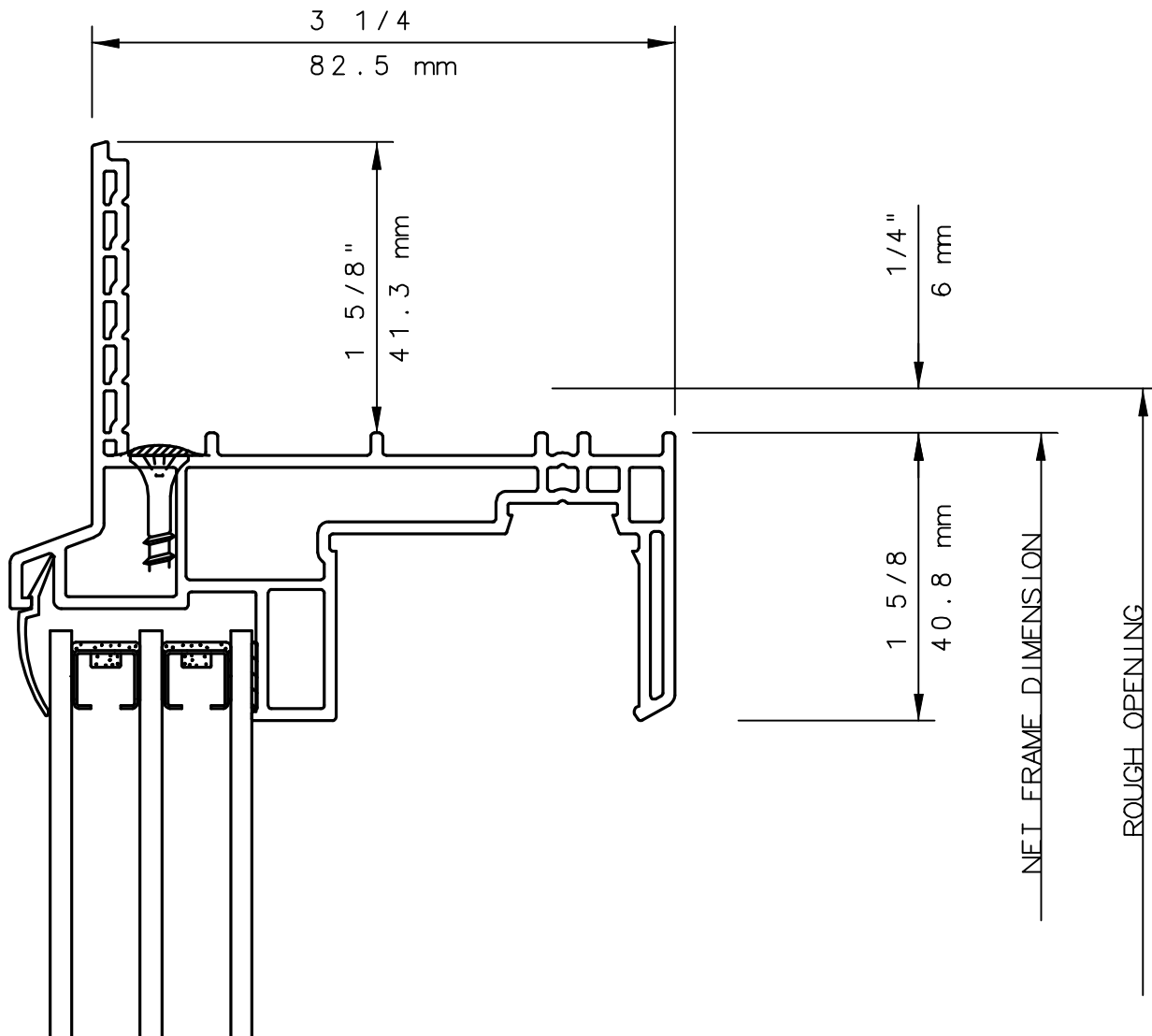

NOTE

THIS IS AN ARCHITECTURAL VIEW OF CROSS SECTIONS ONLY AND INSTALLATION OF SHIMS, FASTENERS, AND SEALANT SHALL BE THE RESPONSIBILITY OF THE INSTALLER.

INTERNATIONAL WINDOW - NORTHERN CAL.

30526 SAN ANTONIO STREET
HAYWARD, CALIFORNIA 94544
(510) 487-1122 ORDER DESK (510) 487-1234
FAX # (510) 471-9387 OR (510) 489-3020

INTERNATIONAL WINDOW CORPORATION

1551 EAST ORANGETHORPE AVE.
FULLERTON, CALIFORNIA 92831
(562) 928-6411 (800) 477-4032
FAX # (562) 928-3492

IWC

SERIES 5460 SINGLE HUNG WINDOW SILL DETAIL 22

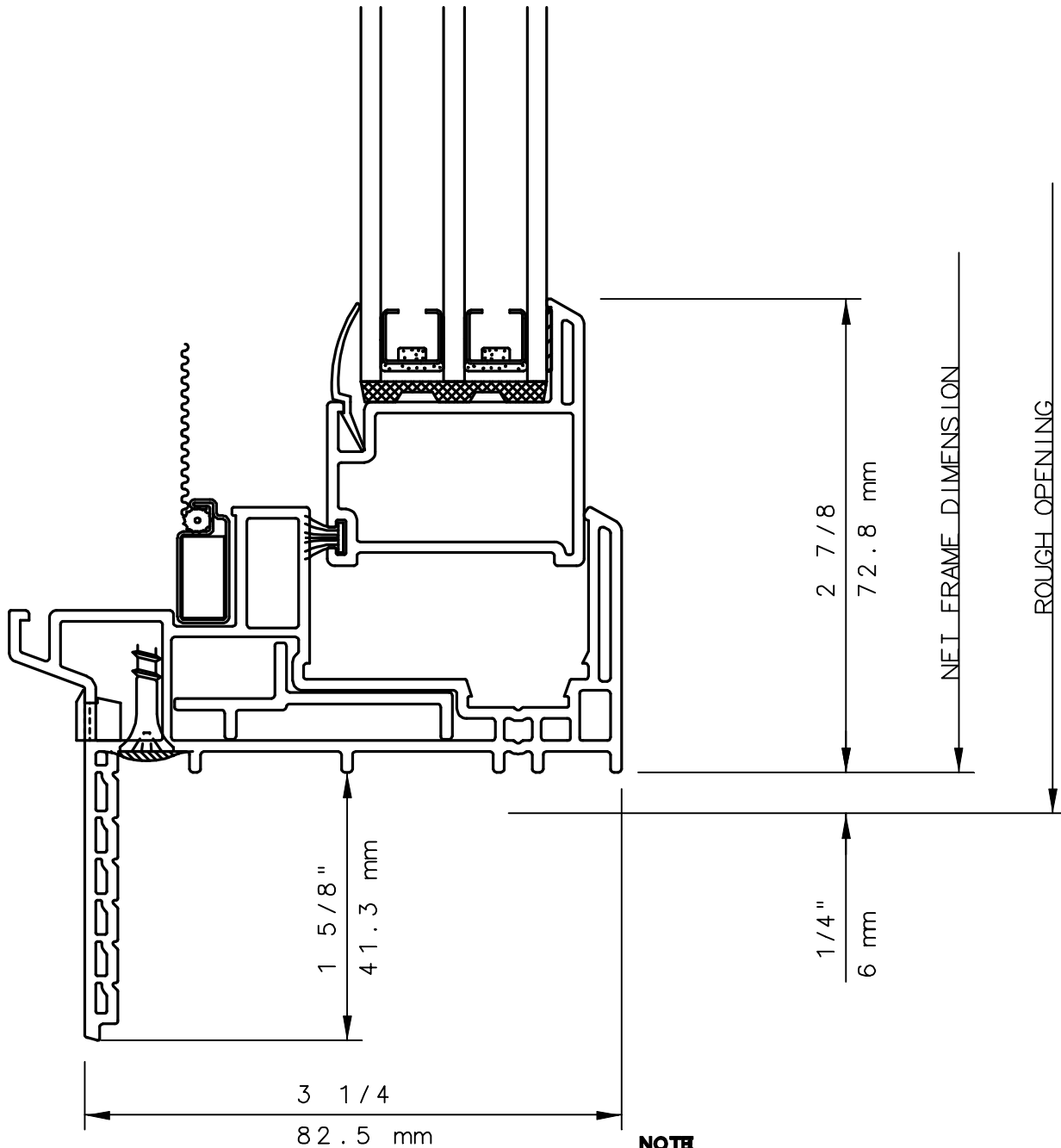

NOTE

THIS IS AN ARCHITECTURAL VIEW OF CROSS SECTIONS ONLY AND INSTALLATION OF SHIMS, FASTENERS, AND SEALANT SHALL BE THE RESPONSIBILITY OF THE INSTALLER.

INTERNATIONAL WINDOW - NORTHERN CAL.

30526 SAN ANTONIO STREET
HAYWARD, CALIFORNIA 94544
(510) 487-1122 ORDER DESK (510) 487-1234
FAX # (510) 471-9387 OR (510) 489-3020

INTERNATIONAL WINDOW CORPORATION

1551 EAST ORANGETHORPE AVE.
FULLERTON, CALIFORNIA 92831
(562) 928-6411 (800) 477-4032
FAX # (562) 928-3492

IWC

SERIES 5460 SINGLE HUNG WINDOW JAMB DETAIL 23

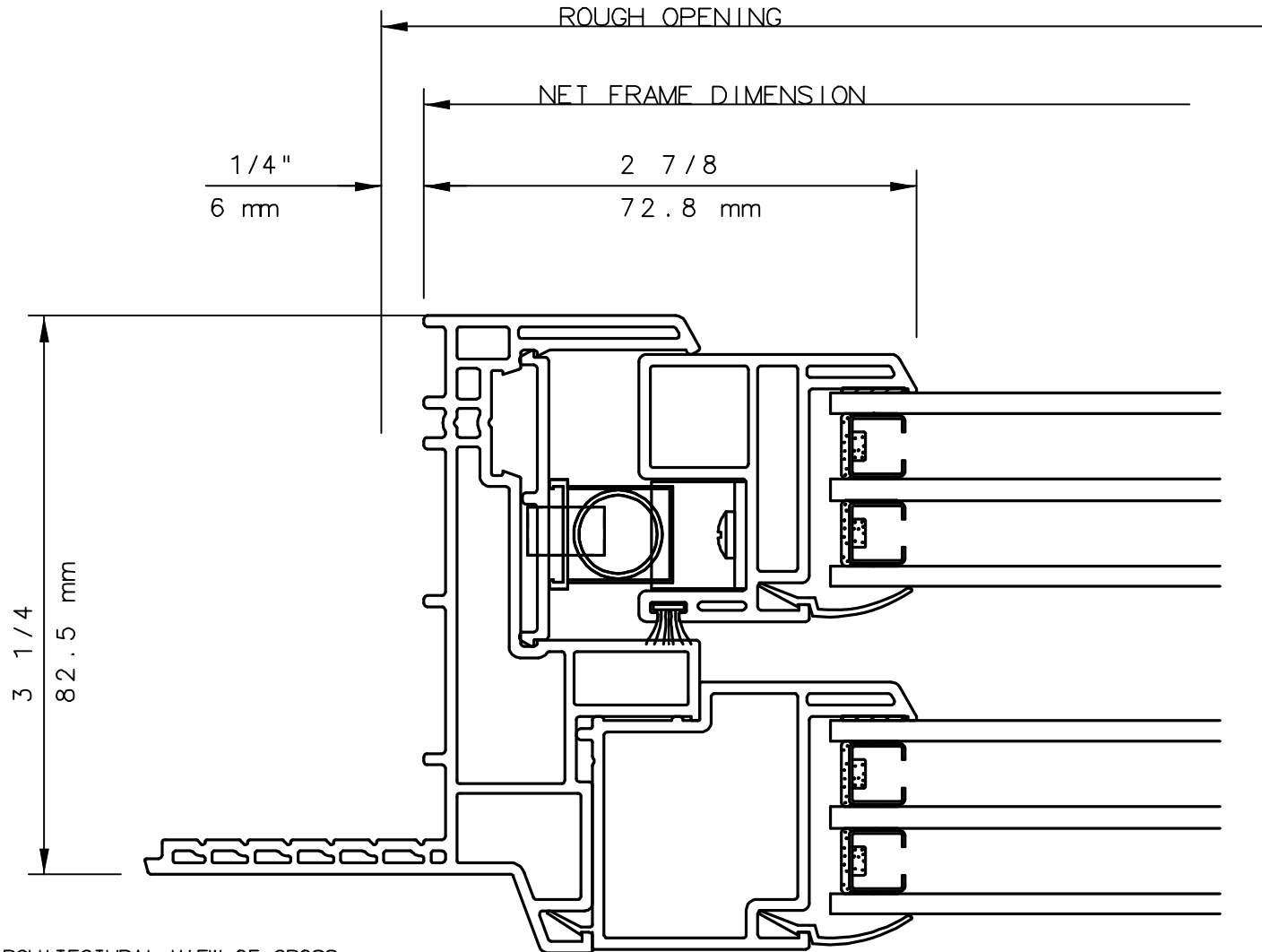

NOTE

THIS IS AN ARCHITECTURAL VIEW OF CROSS SECTIONS ONLY AND INSTALLATION OF SHIMS, FASTENERS, AND SEALANT SHALL BE THE RESPONSIBILITY OF THE INSTALLER.

INTERNATIONAL WINDOW - NORTHERN CAL.

30526 SAN ANTONIO STREET
HAYWARD, CALIFORNIA 94544
(510) 487-1122 ORDER DESK (510) 487-1234
FAX # (510) 471-9387 OR (510) 489-3020

INTERNATIONAL WINDOW CORPORATION

1551 EAST ORANGETHORPE AVE.
FULLERTON, CALIFORNIA 92831
(562) 928-6411 (800) 477-4032
FAX # (562) 928-3492

IWC

SERIES 5420/21/60/80 SINGLE HUNG WINDOW
INTERLOCK DETAIL 24

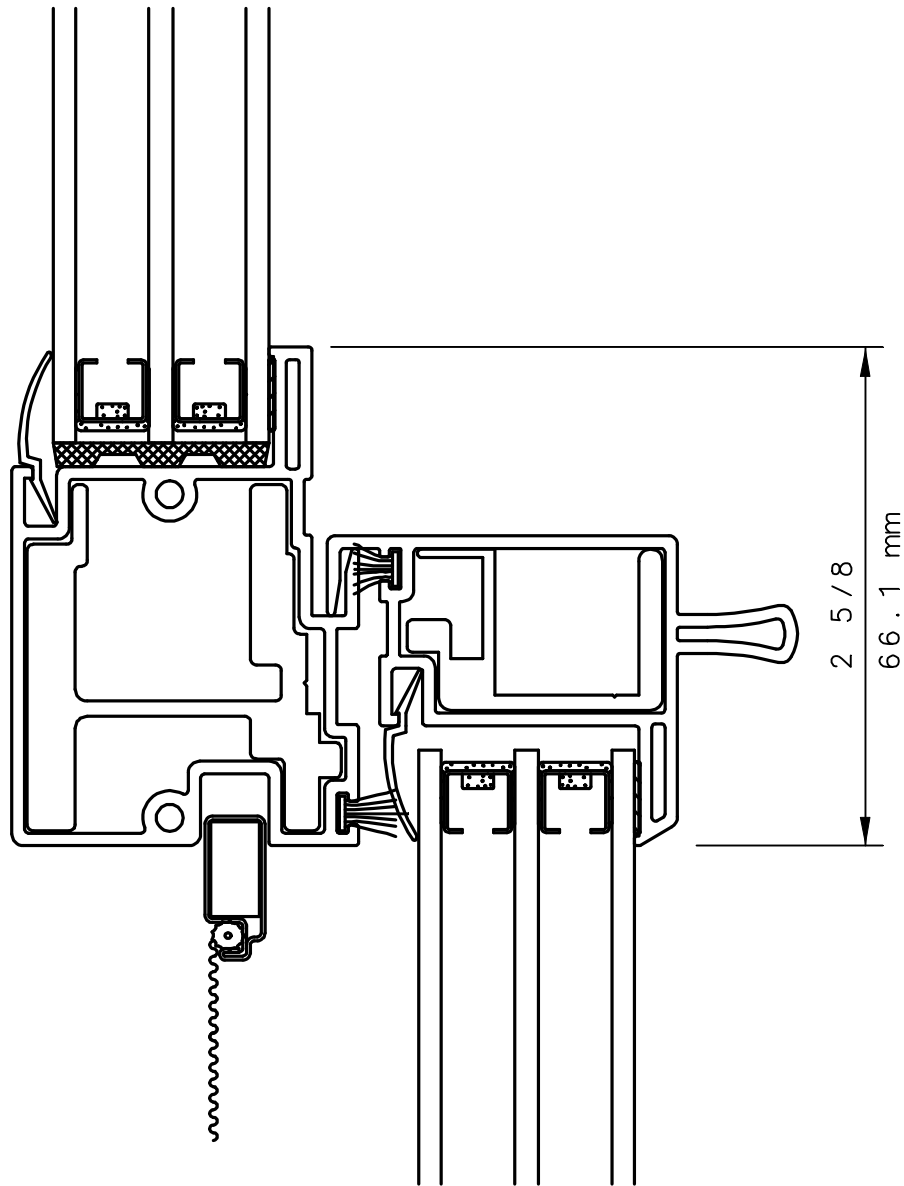

NOTE

THIS IS AN ARCHITECTURAL VIEW OF CROSS SECTIONS ONLY AND INSTALLATION OF SHIMS, FASTENERS, AND SEALANT SHALL BE THE RESPONSIBILITY OF THE INSTALLER.

INTERNATIONAL WINDOW - NORTHERN CAL.

30526 SAN ANTONIO STREET
HAYWARD, CALIFORNIA 94544
(510) 487-1122 ORDER DESK (510) 487-1234
FAX # (510) 471-9387 OR (510) 489-3020

INTERNATIONAL WINDOW CORPORATION

1551 EAST ORANGETHORPE AVE.
FULLERTON, CALIFORNIA 92831
(562) 928-6411 (800) 477-4032
FAX # (562) 928-3492

IWC

SERIES 5420/21/60/80 SINGLE HUNG WINDOW
INTEGRAL MULL SH NEXT O DETAIL 26
(LEFT HAND SHOWN - RIGHT HAND OPPOSITE)

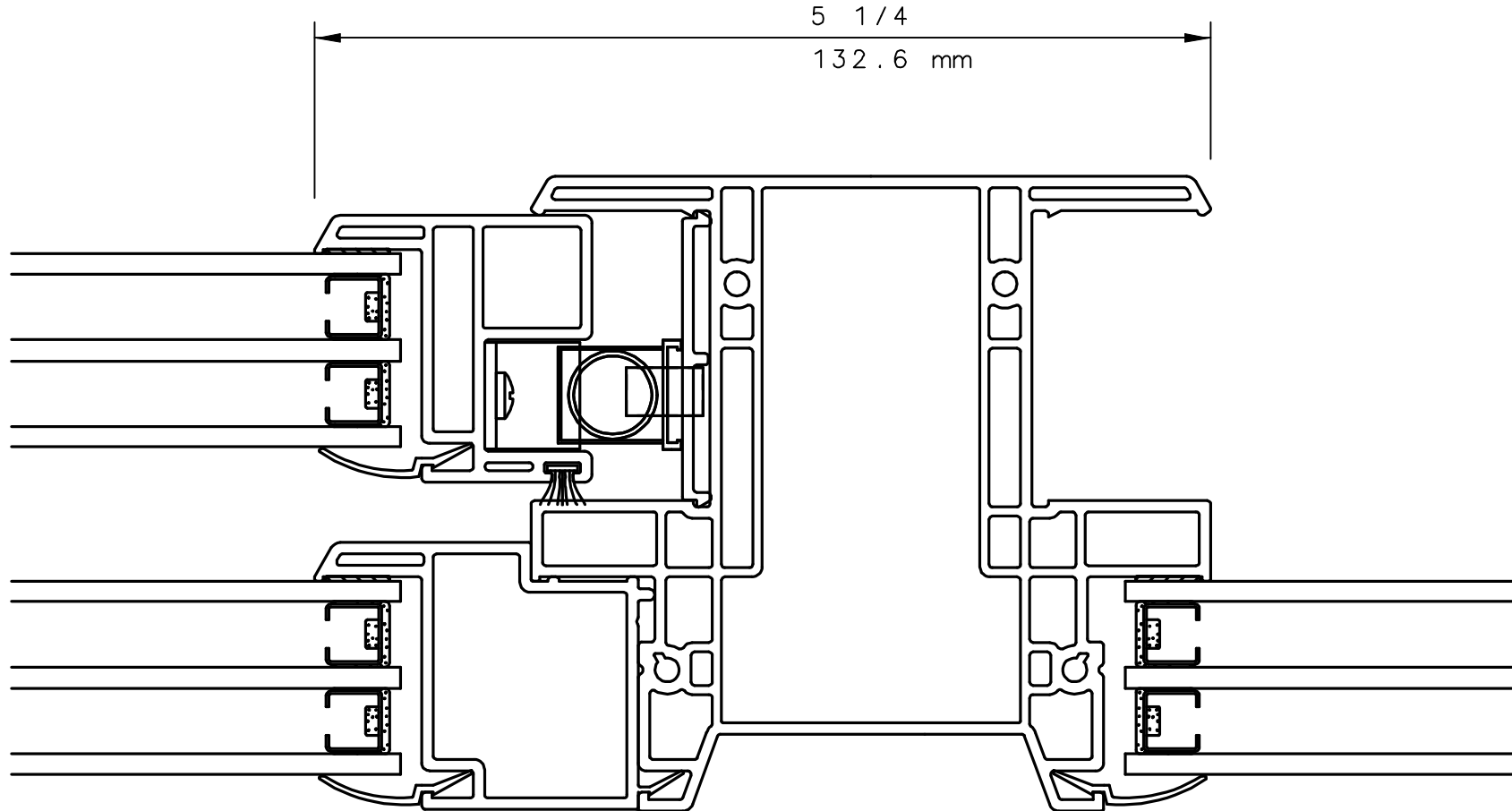

NOTE

THIS IS AN ARCHITECTURAL VIEW OF CROSS SECTIONS ONLY AND INSTALLATION OF SHIMS, FASTENERS, AND SEALANT SHALL BE THE RESPONSIBILITY OF THE INSTALLER.

INTERNATIONAL WINDOW - NORTHERN CAL.

30526 SAN ANTONIO STREET
HAYWARD, CALIFORNIA 94544
(510) 487-1122 ORDER DESK (510) 487-1234
FAX # (510) 471-9387 OR (510) 489-3020

INTERNATIONAL WINDOW CORPORATION

1551 EAST ORANGETHORPE AVE.
FULLERTON, CALIFORNIA 92831
(562) 928-6411 (800) 477-4032
FAX # (562) 928-3492